



T-INOX

STAINLESS STEEL SERIES

2020 CATALOGUE

GASFEDERN – GAS SPRING – MOLLA A GAS



Discover
the potential

UNICERT
ISO 9001:2015



About Our Company

From Tradition
to Innovation

TGS started its industry adventure in early 70s by the producon of machining products for gas springs and various fields of industry. Our early gas spring producon steps started in 1992.

Day afer day we improved our manufacturing technologies and machinery equipments and caught world standards. In 2008 we started exporting our products to european countries and established our export company Tunatek Ltd. Co. for organizing our all export operations.

More than a quarter century of experience in gas spring producon ensures us self-confidence to provide our products all high level markets. Today we manufacture 5 different series in steel and stainless steel materials and dozens of different functions. Customers from about 50 countries and dozen of different industrial sectors rely on different kinds of gas springs made by TGS.



Quality Policy



All our products are designed, manufactured and delivered according to the most strict quality standards. Our experienced and specially trained employees monitor the adherence to our quality criteria in every phase of the production process. Tunalift gas springs are manufactured with the highest quality, environmentally friendly materials.

We are certified in accordance with DIN ISO 9001:2015. Our quality program starts with implementing strict quality controls on our purchase transactions. Permanent quality is guaranteed due to the uncompromisingly monitoring of raw materials, an aggressive testing program and a redundant quality control program throughout the production process.

TGS products are continuously tested to ensure reliability, long life and over all product safety for your highest satisfaction. Using our test and development laboratory, products and technology are constantly being improved.



INDEX



APPLICATION FIELDS [6](#)



SPRING CHARACTERISTICS [7](#)

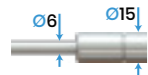

6-15 SERIES [8](#)

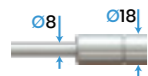

8-18 SERIES [10](#)

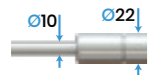

10-22 SERIES [12](#)

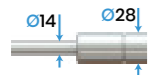

14-28 SERIES [14](#)

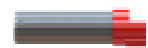

TGS SAFETY LOCK [16](#)



M-JOINT [17](#)

T-INOX SERIES



APPLICATION FIELDS OF T-INOX GAS SPRINGS



Most common applications are;

- Automotive and Trucking Equipment
- Passenger/Locomotive Applications
- Food Processing Equipment
- Military Transport/Vehicles
- Commercial/Recreational Marine Equipment

- Defense Weapons Systems
- Medical/Pharmaceutical/Semi-conductor
- Naval Equipment/Top-side/Sub-sea
- Business Class Aircraft Interiors/Exteriors
- Commercial Aircraft Interiors/Exteriors

DEMONSTRATION VIDEO



Scan for watch video on youtube

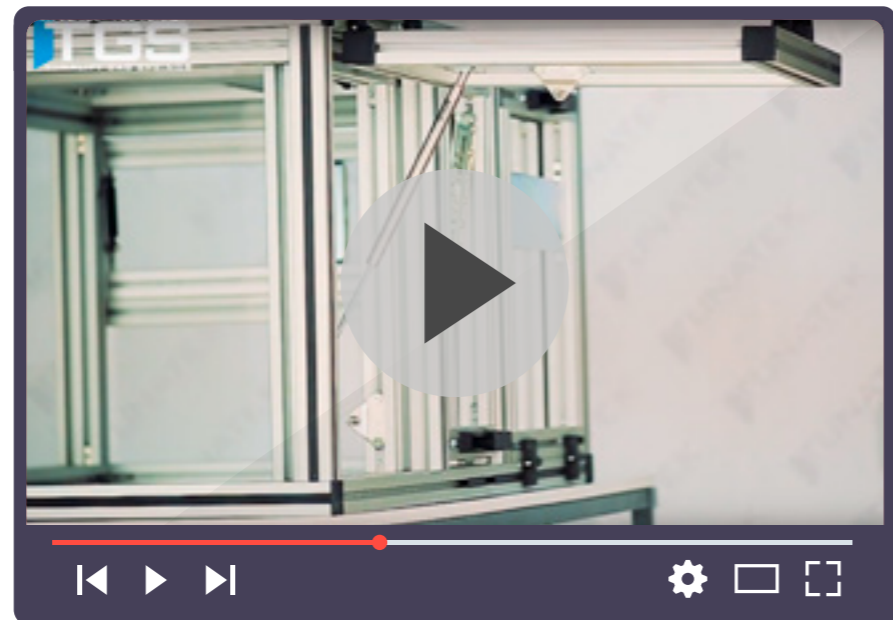

Spring Characteristics T-INOX SERIES

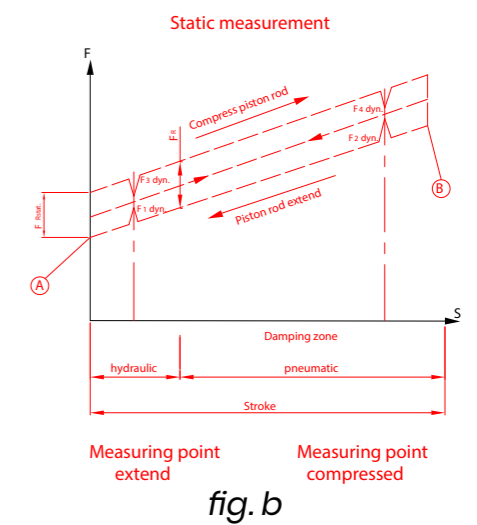
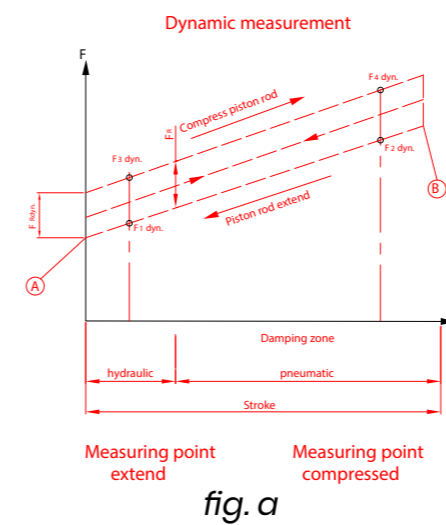
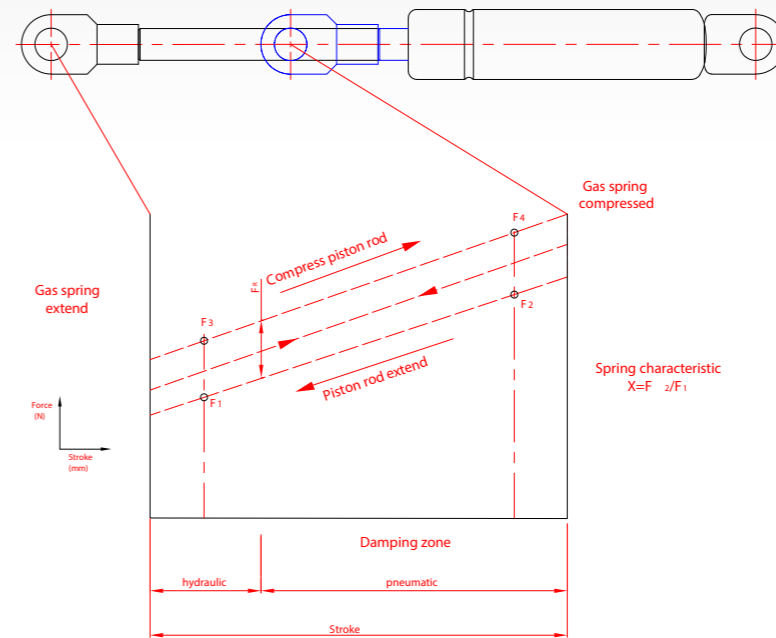

The spring characteristic curve shows the force path of the gas spring over the stroke, from the extended to the retracted state and back. The spring characteristic illustrates the balance of power of F_2/F_1 . For the design of gas springs, the force F_1 is, in addition to the dimensions, the most important criterion. The force F_1 is measured 5mm before the end of the extension movement and thus defies the value of the spring force.

Gas Springs are being measured by two methods; Dynamic measurement and Static measurement. In Dynamic measurement (fig.a) method test equipment records the force reaction during compression/extension at the same constant velocity. The Static measurement (fig.b) is performed with a constant speed similar to the Dynamic measurement. However, test equipment interrupts the motion at the measuring points and the spring force is being measured in a static condition.

IH.100.239 - 100N - Y524S - B001S - RV15

REFERENCE NO

F1

ROD MOUNTING

TUBE MOUNTING

ADDITIONAL ACCESSORIES

select from list

pressure rate

optional









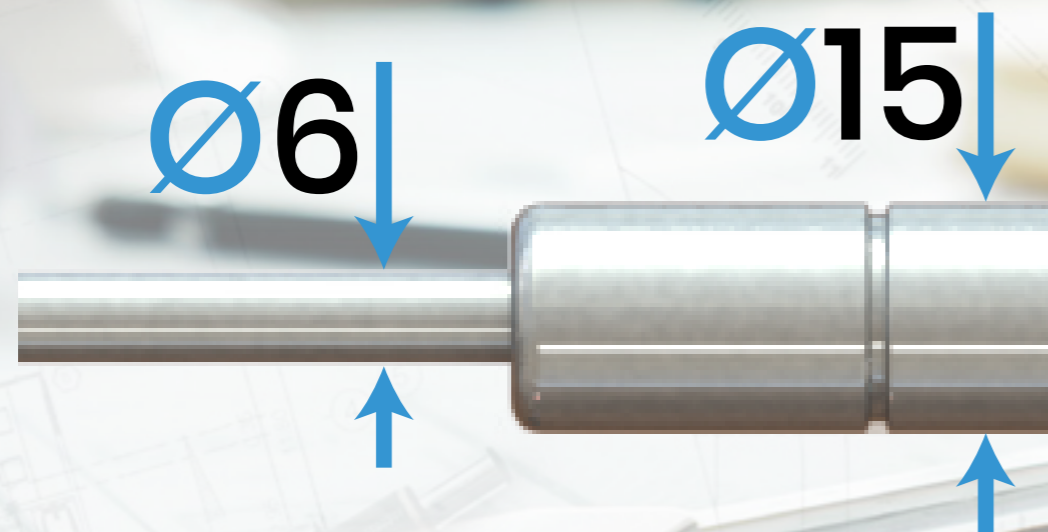
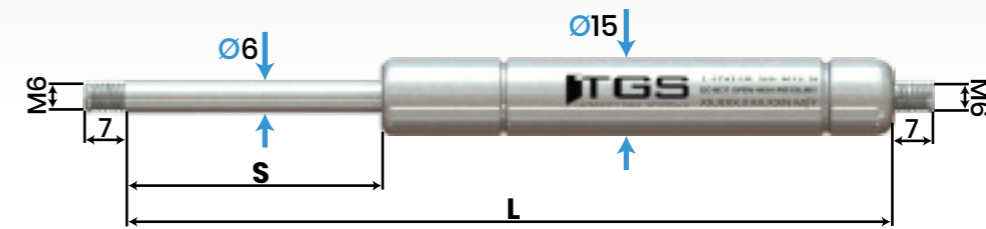

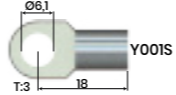
optional

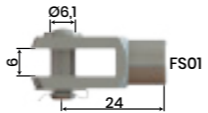
optional

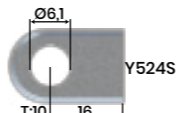

Order Example

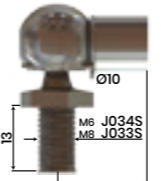

	S	L	F1	REF. NO	
	STROKE LENGTH	EXTENDED LENGTH	PRESSURE RATE		
	20	86	50N - 400N	IH.20.86	
	30	100	50N - 400N	IH.30.100	
	40	126	50N - 400N	IH.40.126	
	50	156	50N - 400N	IH.50.156	
	60	162	50N - 400N	IH.60.126	
	73	184	50N - 400N	IH.73.184	
	75	215	50N - 400N	IH.75.215	
	80	199	50N - 400N	IH.80.199	
	90	270	50N - 400N	IH.90.270	
	100	239	50N - 400N	IH.100.239	
	120	282	50N - 400N	IH.120.282	
	140	345	50N - 400N	IH.140.345	
	150	342	50N - 400N	IH.150.342	
	170	395	50N - 400N	IH.170.395	
	180	434	50N - 350N	IH.180.434	
	200	442	50N - 350N	IH.200.442	



M-JOINT

MJ15-10S / Extends L +10mm

MJ15-15S / Extends L +15mm

M-JOINT extends length of standard item with mounting on tube end. Please check page 17 for detailed information.



VALVE

Order identification code:



RV15

Lets you to reduce gas spring pressure according to your requirement. Requires +10mm in extended length.

JA.100.249 - 100N - Y019S - B001S - MJ18 - 10S

REFERENCE NO

F1

ROD MOUNTING

TUBE MOUNTING

ADDITIONAL ACCESSORIES

select from list

pressure rate

optional

optional

optional



Order Example

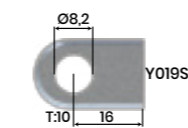
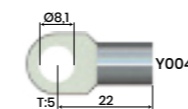
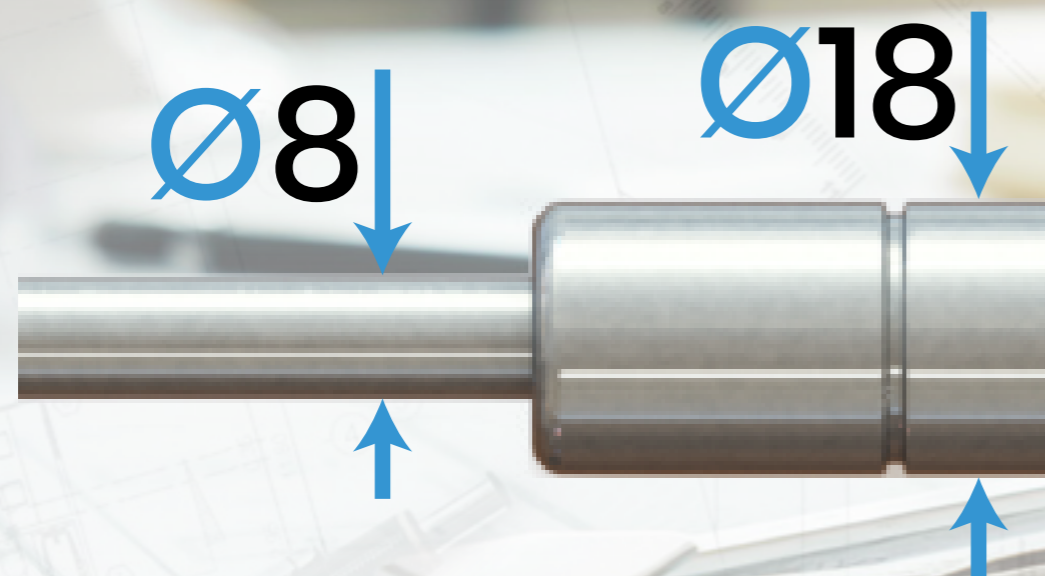

S	L	F1	REF. NO
STROKE LENGTH	EXTENDED LENGTH	PRESSURE RATE	
50	155	50N - 750N	JA.50.155
60	169	50N - 750N	JA.60.169
75	214	50N - 750N	JA.75.214
80	209	50N - 750N	JA.80.209
90	265	50N - 750N	JA.90.265
100	249	50N - 750N	JA.100.249
120	289	50N - 750N	JA.120.289
140	345	50N - 750N	JA.140.345
150	395	50N - 750N	JA.150.395
160	370	50N - 750N	JA.160.370
170	394	50N - 750N	JA.170.394
180	409	50N - 750N	JA.180.409
200	450	50N - 750N	JA.200.450
220	491	50N - 750N	JA.220.491
250	550	50N - 750N	JA.250.550



M-JOINT

MJ18-10S / Extends L +10mm

MJ18-15S / Extends L +15mm

M-JOINT extends length of standard item with mounting on tube end. Please check page 17 for detailed information.



Order identification code:



RV18

Lets you to reduce gas spring pressure according to your requirement. Requires +10mm in extended length.



Order identification code:



LT18S

External mechanical lock, blocks gas spring in extended position. Please check page 15 for detailed information.









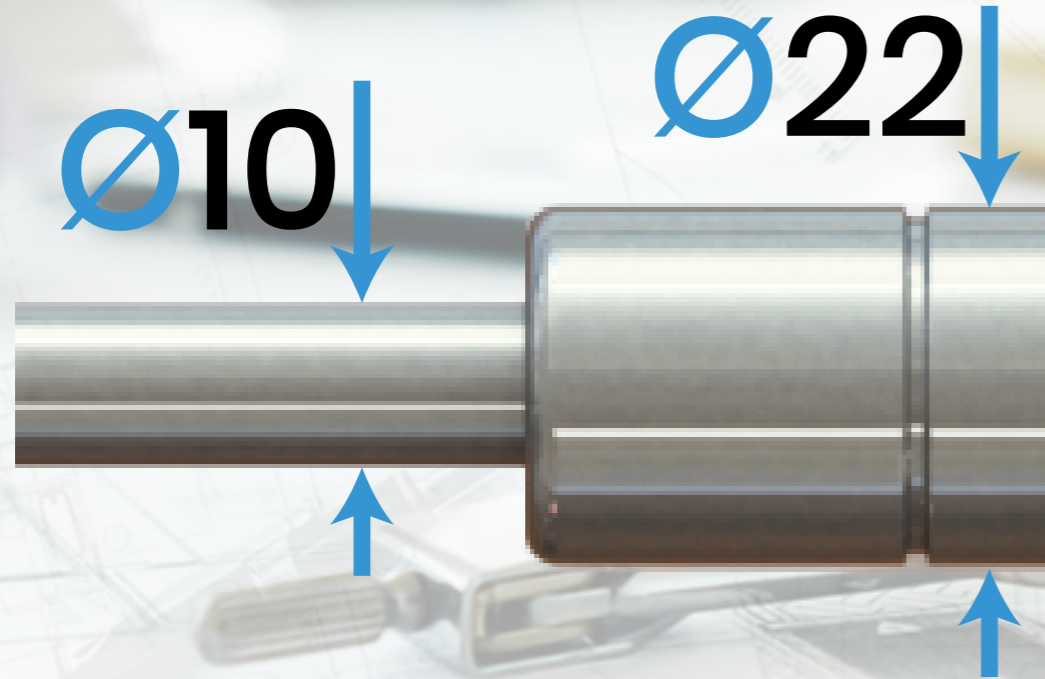

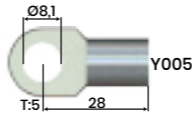
KA.100.248 - 500N - Y009S - B005S - RV22

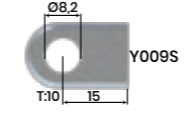
REFERENCE NO	F1	ROD MOUNTING	TUBE MOUNTING	ADDITIONAL ACCESSORIES
select from list	pressure rate	optional	optional	optional

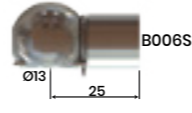

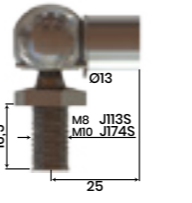
Order Example

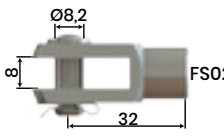

	S STROKE LENGTH	L EXTENDED LENGTH	F1 PRESSURE RATE	REF. NO	
	50	164	100N - 1200N	KA.50.164	
	100	248	100N - 1200N	KA.100.248	
	150	349	100N - 1200N	KA.150.349	
	200	449	100N - 1200N	KA.200.449	
	250	548	100N - 1200N	KA.250.548	
	290	650	100N - 1200N	KA.290.650	
	300	648	100N - 1200N	KA.300.648	
	350	741	100N - 1200N	KA.350.741	
	400	848	100N - 1200N	KA.400.848	
	450	964	100N - 1200N	KA.450.964	
	500	1064	100N - 1200N	KA.500.1064	

M-JOINT
MJ22-15S / Extends L +15mm
MJ22-20S / Extends L +20mm
 M-JOINT extends length of standard item with mounting on tube end. Please check page 17 for detailed information.



VALVE
 Order identification code: **RV22**
 Lets you to reduce gas spring pressure according to your requirement. Requires +10mm in extended length.



TSL
 Order identification code: **LT22S**
 External mechanical lock blocks gas spring in extended position. Please check page 15 for detailed information.



LK.100.266 - 900N - Y039S - Y039S - RV28

REFERENCE NO

F1

ROD MOUNTING

TUBE MOUNTING

ADDITIONAL ACCESSORIES

select from list

pressure rate

optional









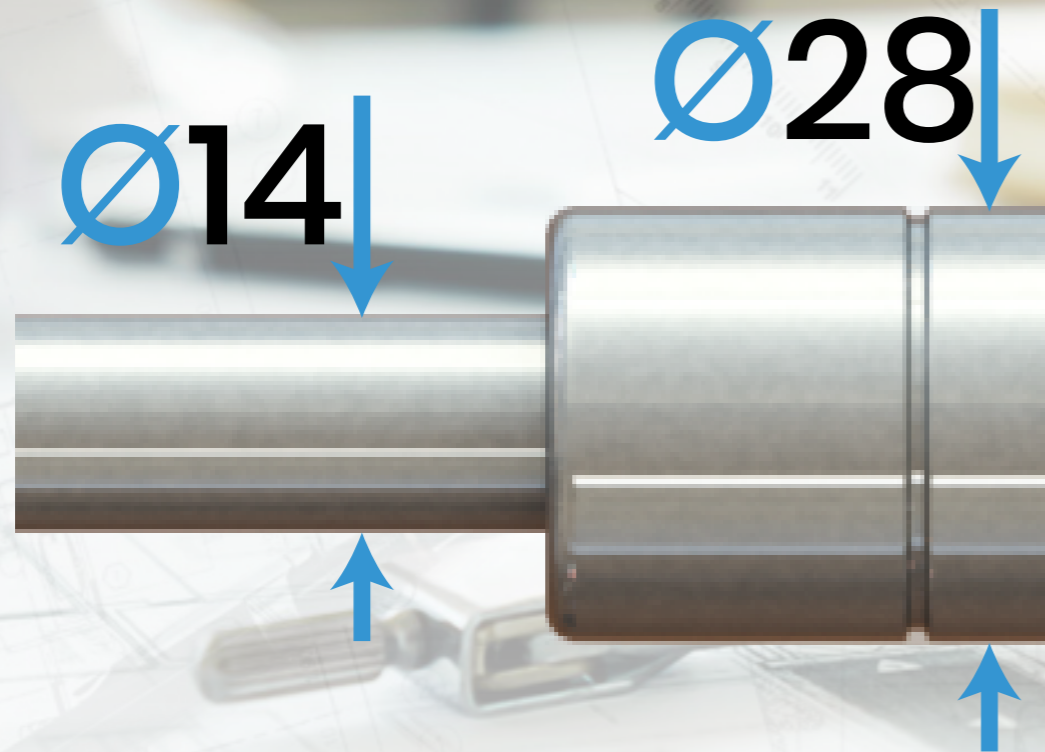
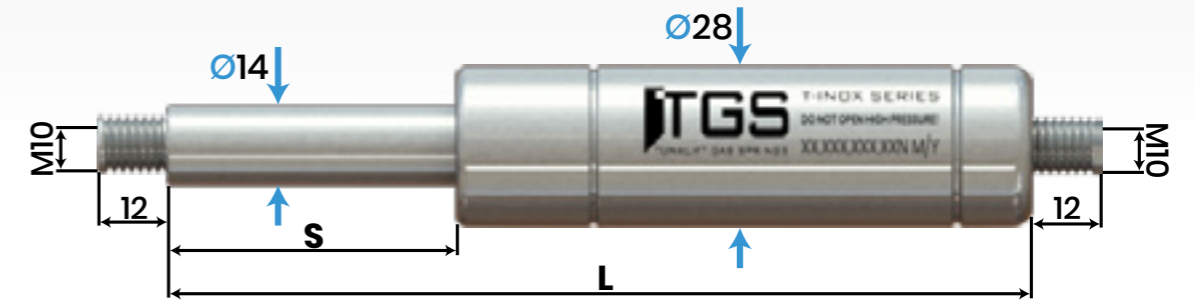

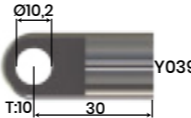

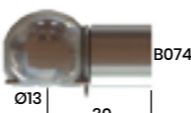

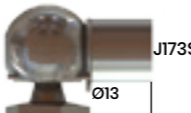

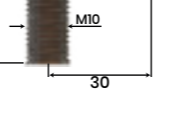
optional

optional

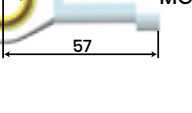

Order Example

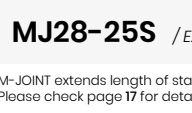
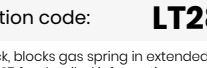

	S	L	F1	REF. NO	
	STROKE LENGTH	EXTENDED LENGTH	PRESSURE RATE		
	100	266	150N - 2500N	LK.100.266	
	150	366	150N - 2500N	LK.150.366	
	200	466	150N - 2500N	LK.200.466	
	250	566	150N - 2500N	LK.250.566	
	300	666	150N - 2500N	LK.300.666	
	350	766	150N - 2500N	LK.350.766	
	400	862	150N - 2500N	LK.400.862	
	450	962	150N - 2500N	LK.450.962	
	500	1060	150N - 2500N	LK.500.1066	



M-JOINT
MJ28-15S / Extends L +15mm
MJ28-25S / Extends L +25mm



Order identification code: **RV28**



Order identification code: **LT28S**

M-JOINT extends length of standard item with mounting on tube end. Please check page 17 for detailed information.

Lets you to reduce gas spring pressure according to your requirement. Requires +10mm in extended length.

External mechanical lock blocks gas spring in extended position. Please check page 15 for detailed information.

TSL

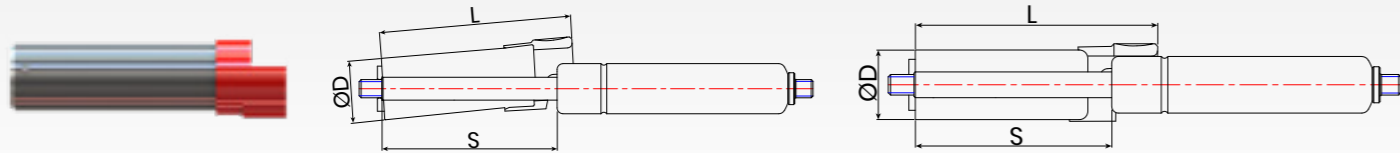

TGS Safety Lock (TSL) is an optional device which serves as external mechanical locking for T-INOX series gas springs. TSL operates automatically with spring loaded button. When the gas spring is in fully extended position TSL automatically blocks the moving way of the piston rod. In order to compress the gas spring back operator has to press "PRESS" button which is made of plastic. Even though main task of TSL is to prevent non-initiative falling downs, it also serves as piston rod protector from dirt, impacts and all kind of external damages.

ITEM	FOR	ØD	L	Stroke Shortage
LT18	8/18	24	S + 8	10MM
LT22	10/22	28	S + 8	10MM
LT28	120	32	S + 20	10MM



M-JOINT EXTENDERS FOR T-INOX SERIES GAS SPRINGS

M-JOINT is original gas spring length extender which designed and patented by TGS. It has monoblock steel design, which gives original tube end shape with both side connection thread (male-female) accordingly.

M-JOINT designed to give more variety to standard range T-MOTION, T-BLOCK, T-INOX, T-TRACTION and T-CLICK gas springs. This simple part will help distributors and stock keepers to keep less variety with maximum opportunity.

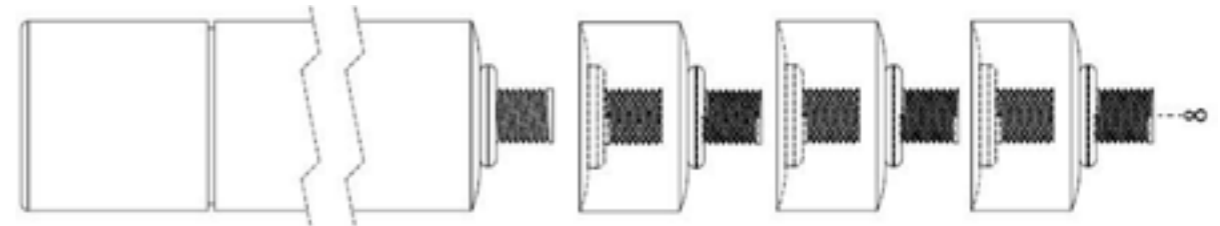
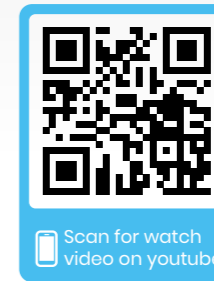

> Clutched form gives durability and resists all pressures.

> Tube end shape gives originally integrated part appearance.



A15 : 400N
A22 : 1200N
A28 : 2500N

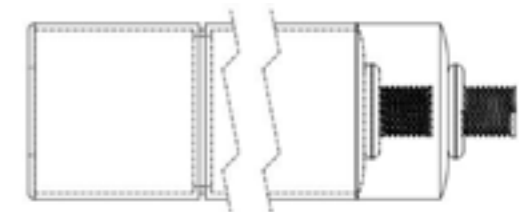



M-JOINT

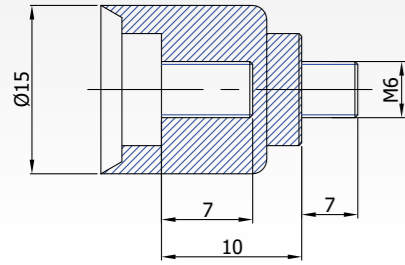

FEATURES MJ15-10S

Material Information	Stainless steel / AISI 304
MJ15-10S/1	AISI 316
Compatible With	S15, S18
Unit Weight	0,009 KG

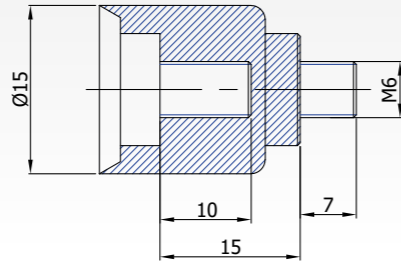

FEATURES MJ15-15S

Material Information	Stainless steel / AISI 304
MJ15-15S/1	AISI 316
Compatible With	S15, S18
Unit Weight	0,009 KG

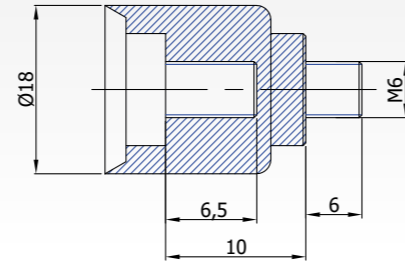

FEATURES MJ18-10S

Material Information	Stainless steel / AISI 304
MJ18-10S/1	AISI 316
Compatible With	S15, S18
Unit Weight	0,009 KG

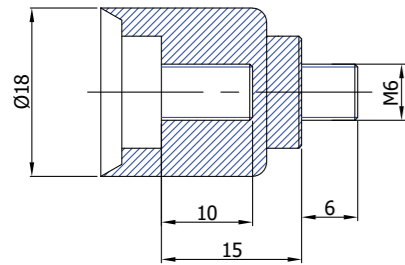

FEATURES MJ18-15S

Material Information	Stainless steel / AISI 304
MJ18-15S/1	AISI 316
Compatible With	S15, S18
Unit Weight	0,009 KG

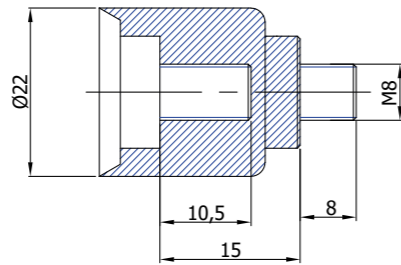

FEATURES MJ22-15S

Material Information	Stainless steel / AISI 304
MJ22-15S/1	AISI 316
Compatible With	S15, S18
Unit Weight	0,009 KG

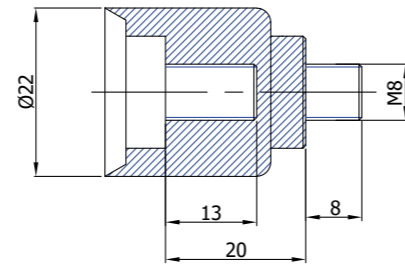

FEATURES MJ22-20S

Material Information	Stainless steel / AISI 304
MJ22-20S/1	AISI 316
Compatible With	S15, S18
Unit Weight	0,009 KG

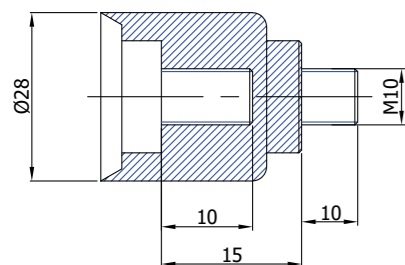

FEATURES MJ28-15S

Material Information	Stainless steel / AISI 304
MJ28-15S/1	AISI 316
Compatible With	S15, S18
Unit Weight	0,009 KG

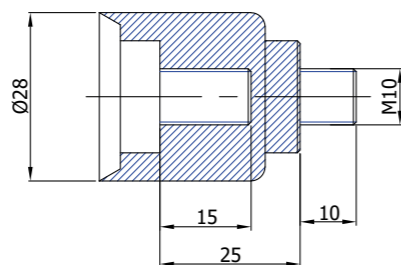

FEATURES MJ28-25S

Material Information	Stainless steel / AISI 304
MJ28-25S/1	AISI 316
Compatible With	S15, S18
Unit Weight	0,009 KG



"Feel Safe!"
www.tunalift.com

Bursa, Turkey

+90 224 211 44 73

info@tunalift.com

www.tunalift.com