



T-BLOCK

LOCKABLE SERIES

2020 CATALOGUE

GASFEDERN – GAS SPRING – MOLLA A GAS



Discover
the potential

UNICERT
ISO 9001:2015



About Our Company

From Tradition
to Innovation

TGS started its industry adventure in early 70s by the producon of machining products for gas springs and various fields of industry. Our early gas spring producon steps started in 1992.

Day afer day we improved our manufacturing technologies and machinery equipments and caught world standards. In 2008 we started exporting our products to european countries and established our export company Tunatek Ltd. Co. for organizing our all export operations.

More than a quarter century of experience in gas spring producon ensures us self-confidence to provide our products all high level markets. Today we manufacture 5 different series in steel and stainless steel materials and dozens of different functions. Customers from about 50 countries and dozen of different industrial sectors rely on different kinds of gas springs made by TGS.



Quality Policy



All our products are designed, manufactured and delivered according to the most strict quality standards. Our experienced and specially trained employees monitor the adherence to our quality criteria in every phase of the production process. Tunalift gas springs are manufactured with the highest quality, environmentally friendly materials.

We are certified in accordance with DIN ISO 9001:2015. Our quality program starts with implementing strict quality controls on our purchase transactions. Permanent quality is guaranteed due to the uncompromisingly monitoring of raw materials, an aggressive testing program and a redundant quality control program throughout the production process.

TGS products are continuously tested to ensure reliability, long life and over all product safety for your highest satisfaction. Using our test and development laboratory, products and technology are constantly being improved.



INDEX

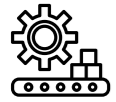

APPLICATION FIELDS [7](#)



SPRING CHARACTERISTICS [8](#)



10-21 SERIES [9](#)



10-27 SERIES [14](#)



LEVER CONTROL [19](#)



WIRE CONTROL [23](#)



HYDRAULIC CONTROL [25](#)



END FITTINGS [30](#)

T-BLOCK LOCKABLE SERIES



Rigid locking in extension

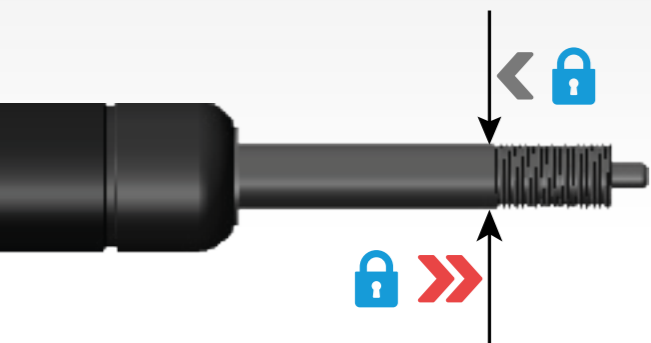

10/21
10/27



Rigid locking in compression

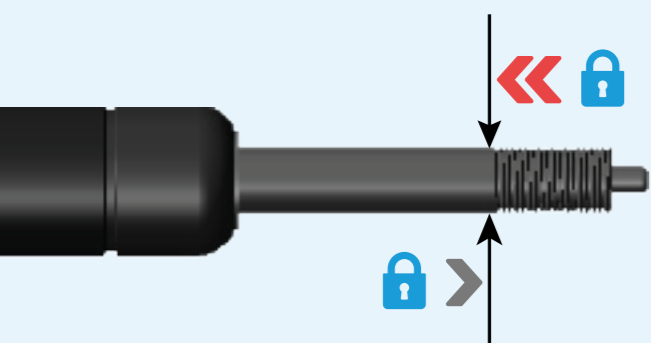

10/21
10/27



Elastic locking

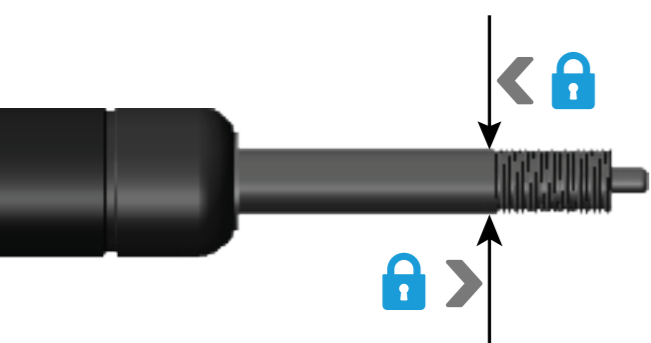

10/21
10/27



APPLICATION FIELDS OF T-BLOCK GAS SPRINGS

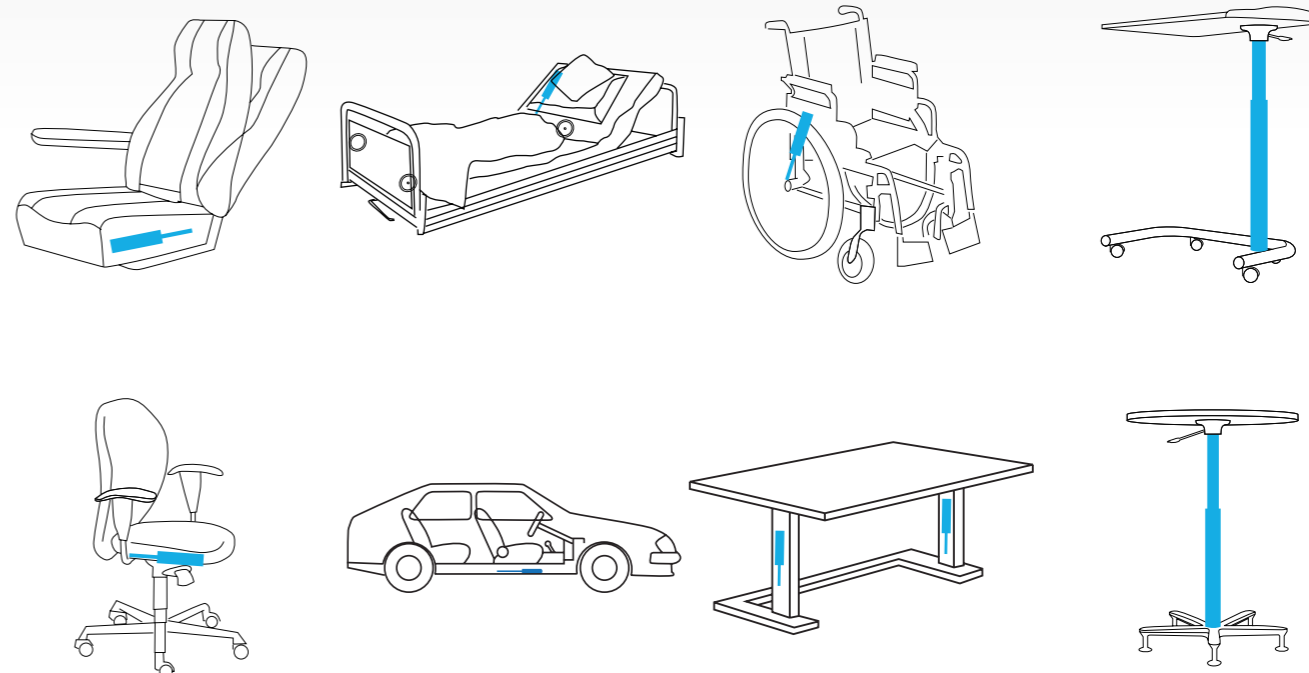

DEMONSTRATION VIDEO



Scan for watch video on youtube



Spring Characteristics

T-BLOCK SERIES

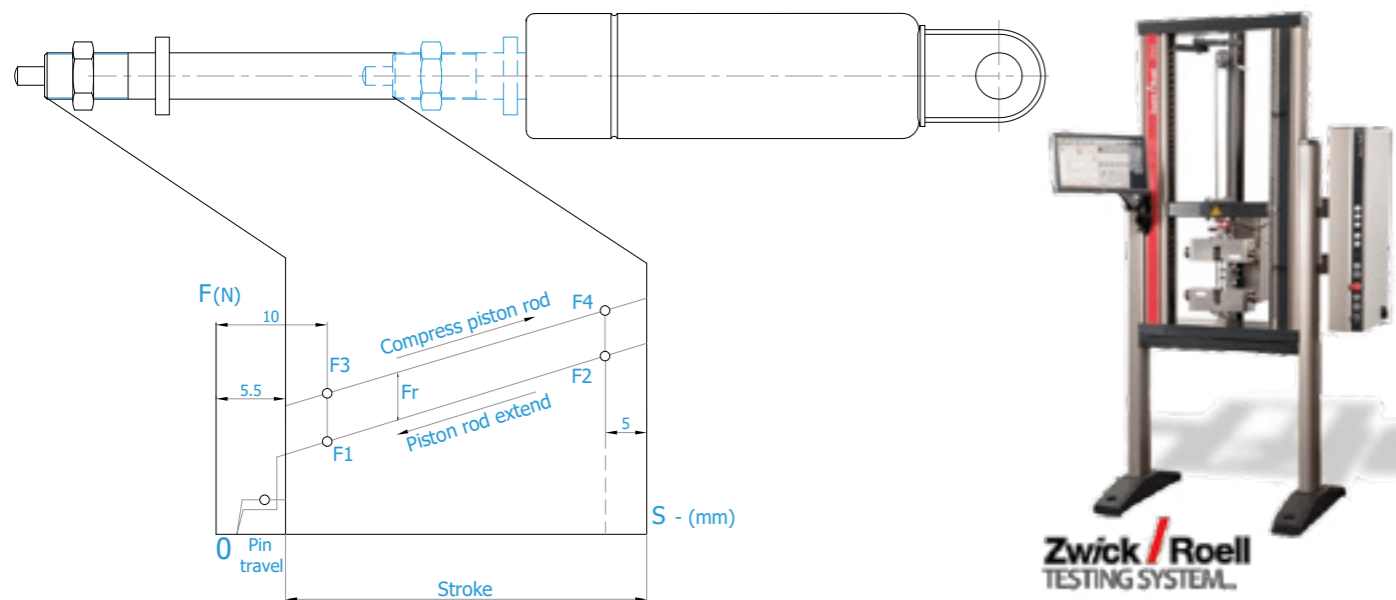

The spring characteristic curve shows the force path of the gas spring over the stroke, from the extended to the retracted state and back. The spring characteristic illustrates the balance of power of F_2/F_1 . For the design of gas springs, the force F_1 is, in addition to the dimensions, the most important criterion. The force F_1 is measured 5mm before the end of the extension movement and thus defies the value of the spring force.

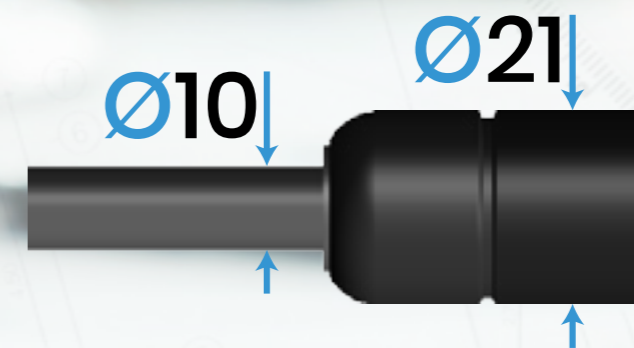

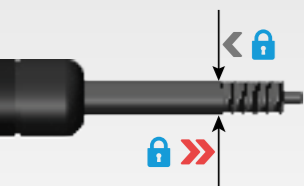

REFERENCE NO

SQ.20.180.200N

Rigid locking in extension
select from list



Order Example

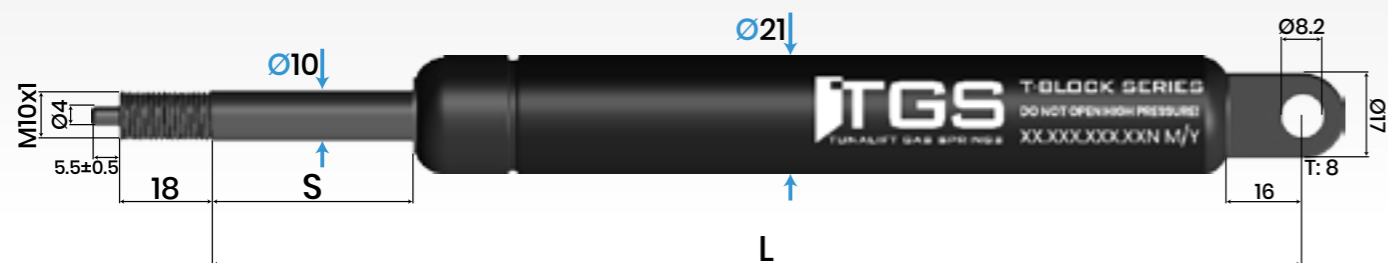

S	L	F1	REF. NO
STROKE LENGTH	EXTENDED LENGTH	PRESSURE RATE	
20	162	200N - 800N	SQ.20.162.F1
30	192	200N - 800N	SQ.30.192.F1
40	212	200N - 800N	SQ.40.212.F1
60	262	200N - 800N	SQ.60.262.F1
80	312	200N - 800N	SQ.80.312.F1
100	367	200N - 800N	SQ.100.367.F1
120	422	200N - 800N	SQ.120.422.F1
160	537	200N - 800N	SQ.160.537.F1
200	647	200N - 800N	SQ.200.647.F1
250	792	200N - 800N	SQ.250.792.F1

Control Units;

Select control unit type



Lever Control

Find more details on page 19



Wire Control

Find more details on page 23

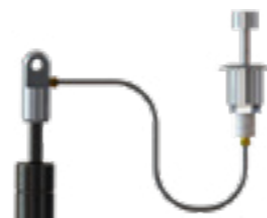

Hydraulic Control

Find more details on page 25

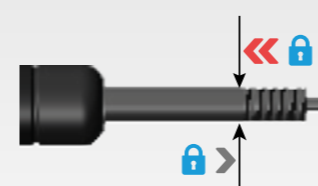

REFERENCE NO

RG.20.187.200N

Rigid locking in compression
select from list



Order Example

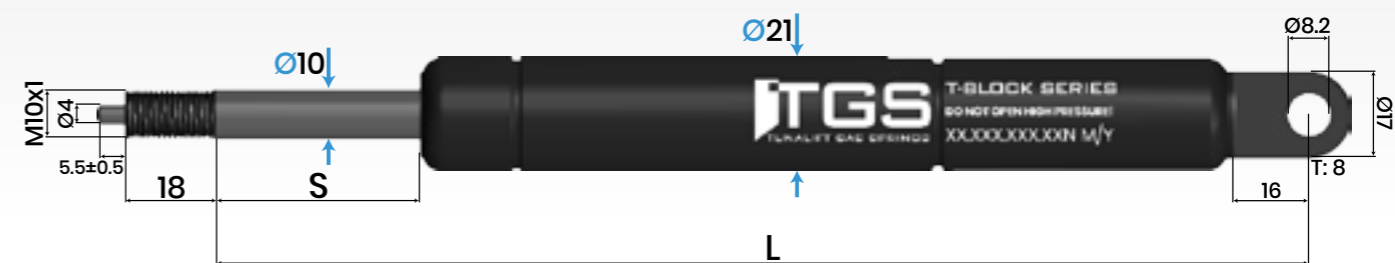

S	L	F1	REF. NO
STROKE LENGTH	EXTENDED LENGTH	PRESSURE RATE	
30	217	200N - 800N	RG.30.217.F1
40	237	200N - 800N	RG.40.237.F1
80	312	200N - 800N	RG.80.312.F1
100	402	200N - 800N	RG.100.402.F1
120	467	200N - 800N	RG.120.467.F1

Control Units;

Select control unit type



Lever Control

Find more details on page 19

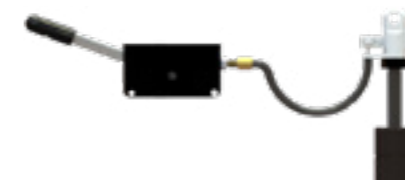

Wire Control

Find more details on page 23



Hydraulic Control

Find more details on page 25

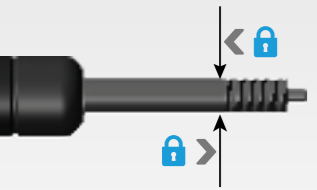

REFERENCE NO

PJ.20.137.200N

Elastic locking

select from list



Order Example

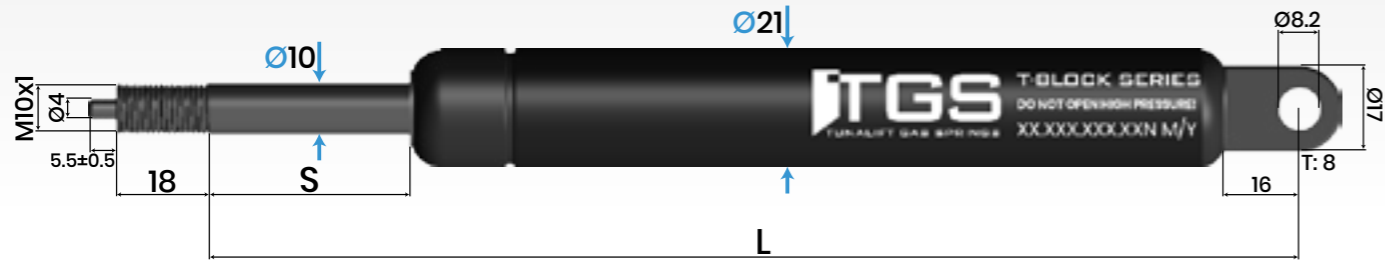

S	L	F1	REF. NO
STROKE LENGTH	EXTENDED LENGTH	PRESSURE RATE	
20	137	200N - 800N	PJ.20.137.F1
30	152	200N - 800N	PJ.30.152.F1
40	172	200N - 800N	PJ.40.172.F1
60	210	200N - 800N	PJ.60.210.F1
80	257	200N - 800N	PJ80.257.F1
100	292	200N - 800N	PJ.100.292.F1
120	372	200N - 800N	PJ.120.372.F1
160	417	200N - 800N	PJ.160.417.F1
200	497	200N - 800N	PJ.200.497.F1
250	697	200N - 800N	PJ.250.697.F1

Control Units;

Select control unit type



Lever Control

Find more details on page 19



Wire Control

Find more details on page 23

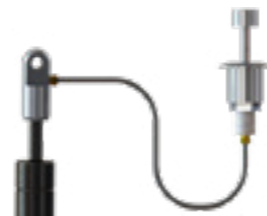

Hydraulic Control

Find more details on page 25

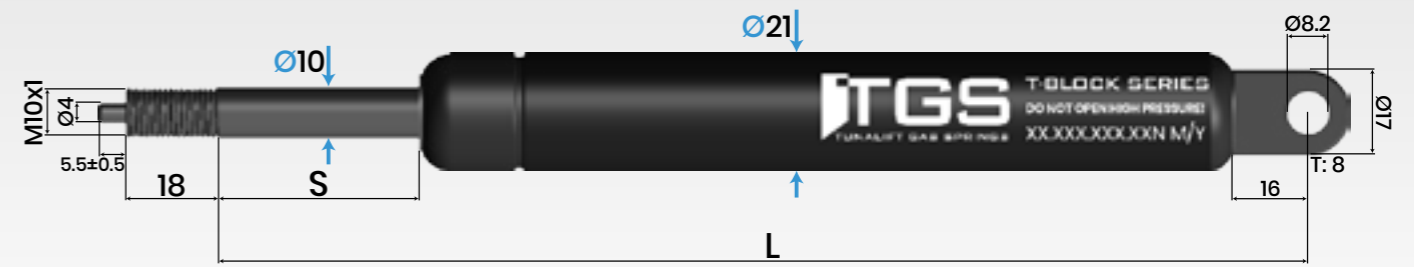

Rod Side Connector

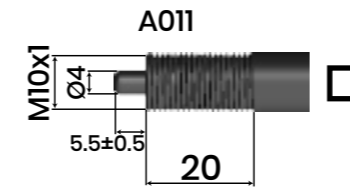
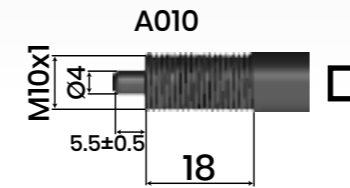

Tube Side Connector

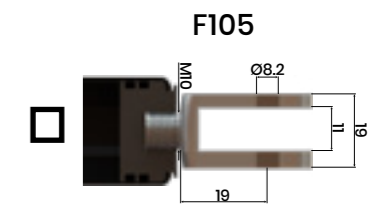
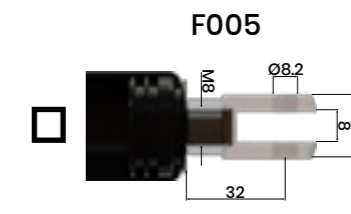
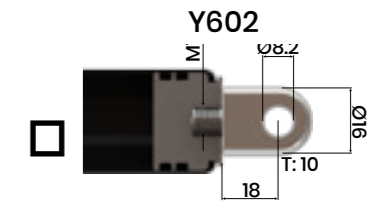
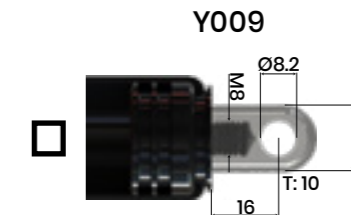
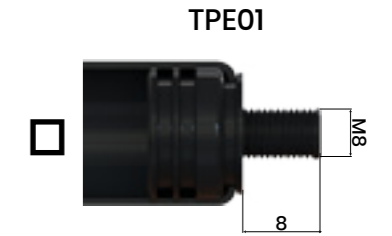
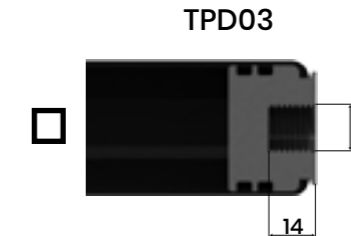
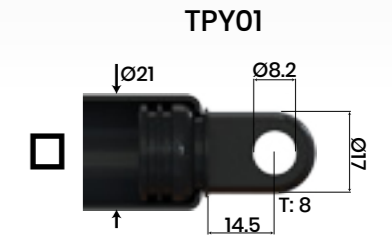
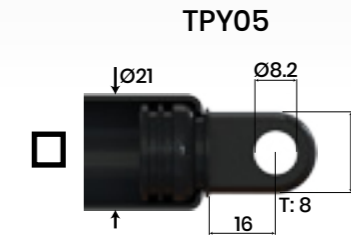

Locking Type

G21: Rigid locking in extension

K21: Rigid locking in compression

E21: Elastic locking

Stroke (S)

G21 = (Stroke x 2) + 75mm

K21 = (Stroke x 2) + 80mm

E21 = (Stroke x 2) + 68mm

Minimum Extended Length (L)

G21 = (Stroke x 2) + 75mm

K21 = (Stroke x 2) + 80mm

E21 = (Stroke x 2) + 68mm

G21.A010.TPY01.160.537.500N

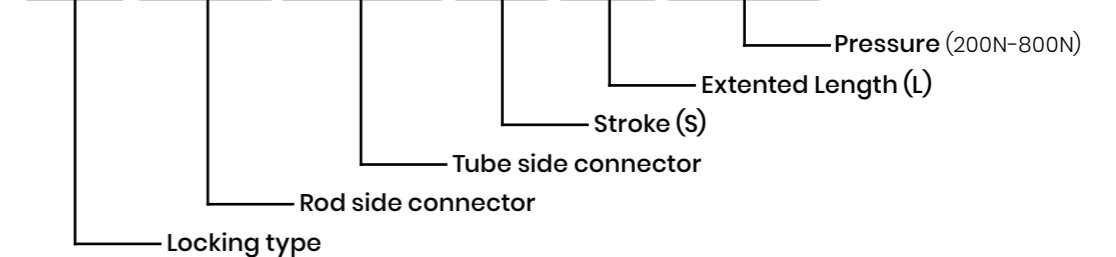

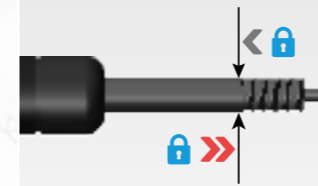

REFERENCE NO

UN.20.187.200N

Rigid locking in extension
select from list

 **Order Example**

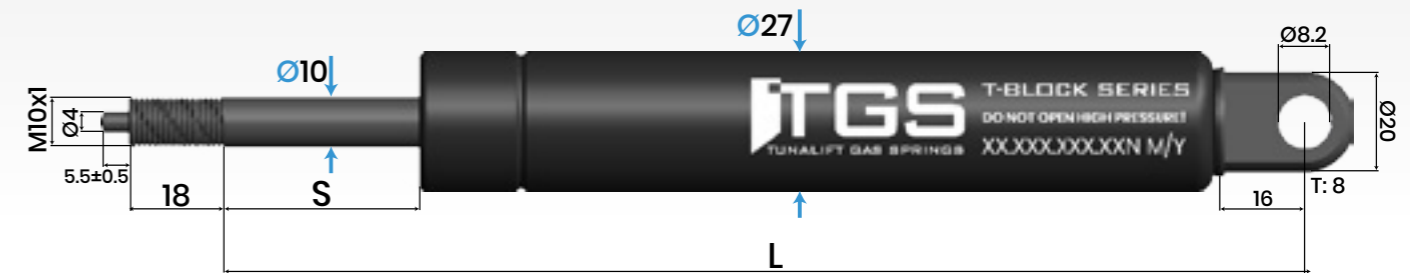

S	L	F1	REF. NO
STROKE LENGTH	EXTENDED LENGTH	PRESSURE RATE	
20	172	200N - 1000N	UN.20.172.F1
30	202	200N - 1000N	UN.30.202.F1
40	223	200N - 1000N	UN.40.223.F1
80	332	200N - 1000N	UN.80.332.F1
100	382	200N - 1000N	UN.100.382.F1
120	432	200N - 1000N	UN.120.432.F1
160	527	200N - 1000N	UN.160.527.F1
200	627	200N - 1000N	UN.200.627.F1

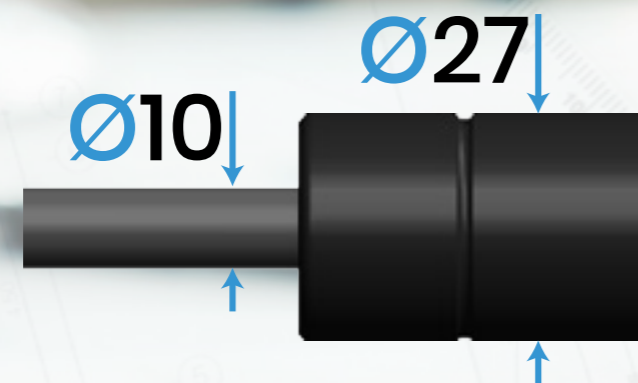

Control Units;

Select control unit type



Lever Control

Find more details on page 19 



Wire Control

Find more details on page 23 



Hydraulic Control

Find more details on page 25 



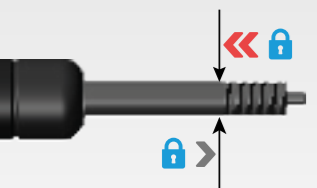

REFERENCE NO
VF.20.187.200N
Rigid locking in compression
select from list

Order Example



S	L	F1	REF. NO
STROKE LENGTH	EXTENDED LENGTH	PRESSURE RATE	
30	174	200N - 1000N	VF.30.174.F1
40	194	200N - 1000N	VF.40.194.F1
60	247	200N - 1000N	VF.60.247.F1
80	292	200N - 1000N	VF.80.292.F1
100	352	200N - 1000N	VF.100.352.F1
120	402	200N - 1000N	VF.120.402.F1
160	492	200N - 1000N	VF.160.492.F1
200	582	200N - 1000N	VF.200.582.F1
250	592	200N - 1000N	VF.250.592.F1

Control Units;
Select control unit type



Lever Control
Find more details on page 19



Wire Control
Find more details on page 23



Hydraulic Control
Find more details on page 25

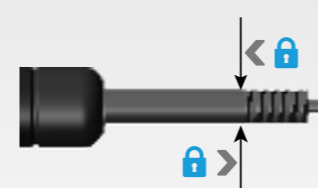

REFERENCE NO
TL.20.187.200N
Elastic locking
select from list

Order Example

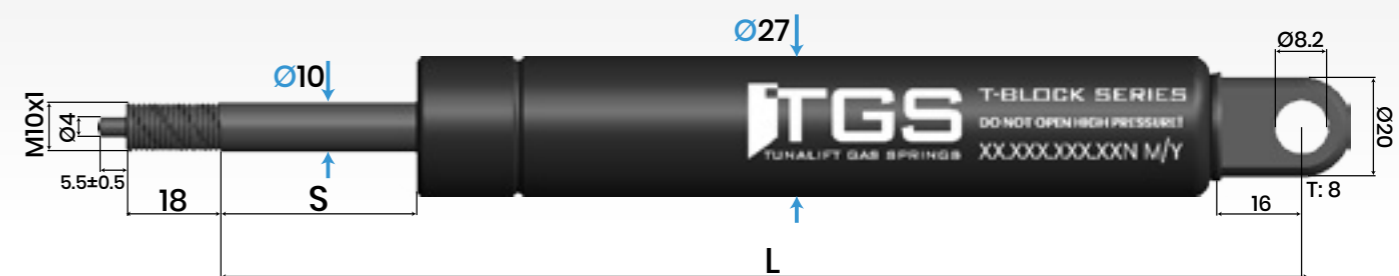

S	L	F1	REF. NO
STROKE LENGTH	EXTENDED LENGTH	PRESSURE RATE	
20	137	200N - 1000N	TL.20.137.F1
30	152	200N - 1000N	TL.30.152.F1
40	172	200N - 1000N	TL.40.172.F1
60	212	200N - 1000N	TL.60.212.F1
80	252	200N - 1000N	TL.80.252.F1
100	292	200N - 1000N	TL.100.292.F1
120	332	200N - 1000N	TL.120.332.F1
160	412	200N - 1000N	TL.160.412.F1
200	492	200N - 1000N	TL.200.492.F1
250	592	200N - 1000N	TL.250.592.F1

Control Units;
Select control unit type



Lever Control
Find more details on page 19



Wire Control
Find more details on page 23



Hydraulic Control
Find more details on page 25

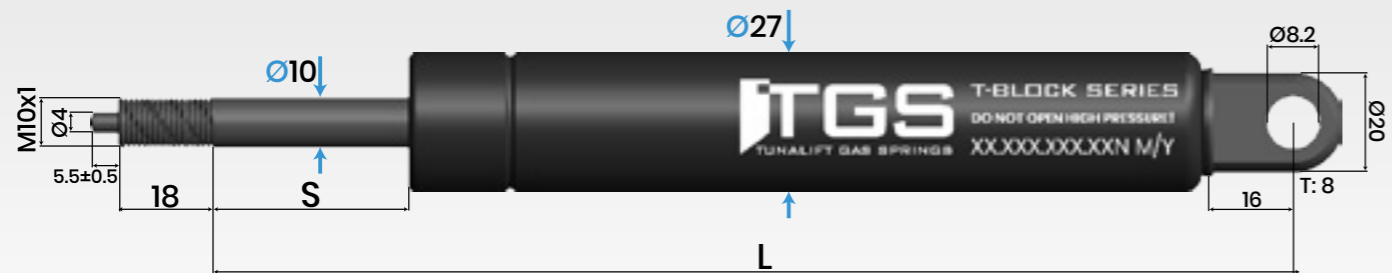

Rod Side Connector

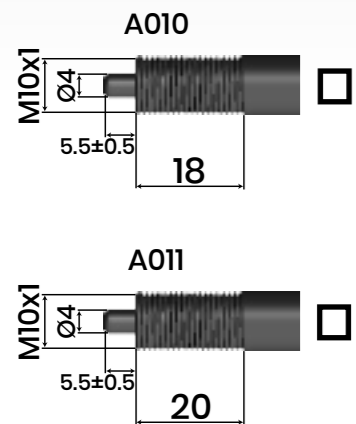

Tube Side Connector

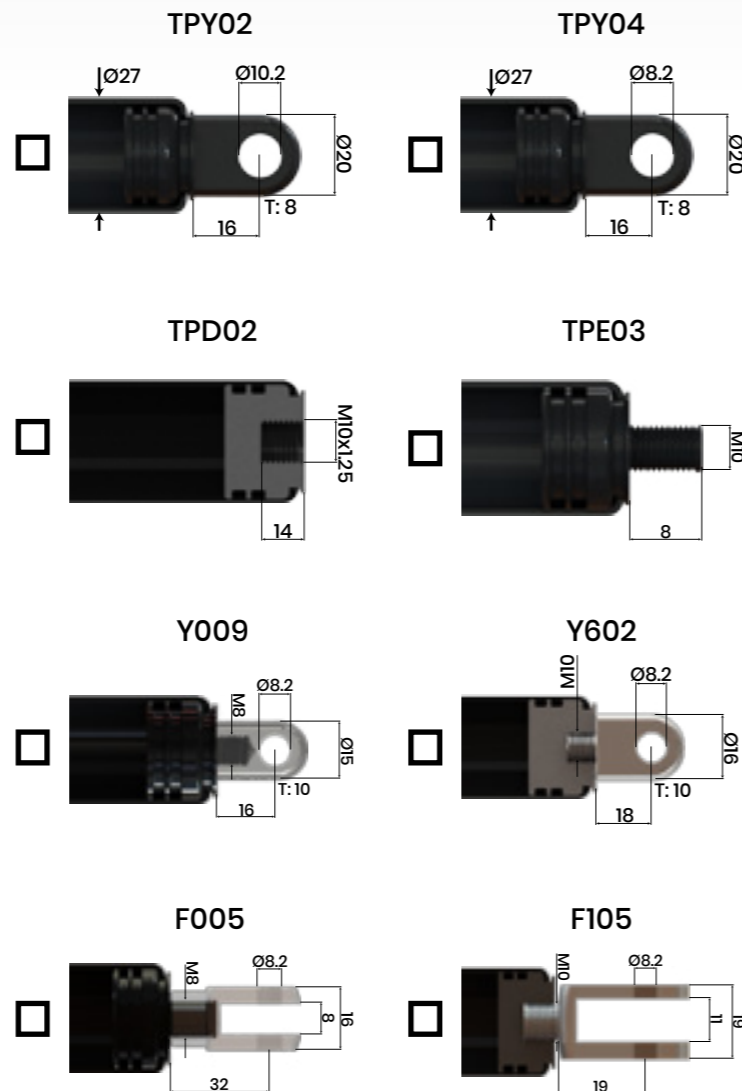

Locking Type

- G27: Rigid locking in extension
- K27: Rigid locking in compression
- E27: Elastic locking

Stroke (S)

- G27 = 20 - 600mm
- K27 = 30 - 300mm
- E27 = 20 - 600mm

Minimum Extended Length (L)

- G27 = (Stroke x 2) + 75mm
- K27 = (Stroke x 2) + 80mm
- E27 = (Stroke x 2) + 68mm

G27.A010.TPY02.160.537.500N

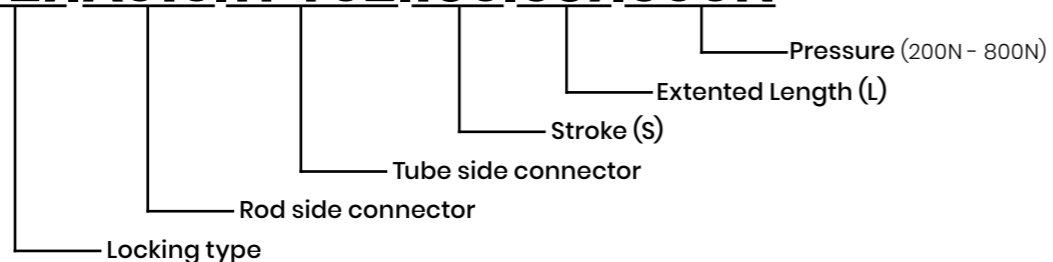

LEVER CONTROL



STANDART LEVER CONTROL



KKM1

FEATURES

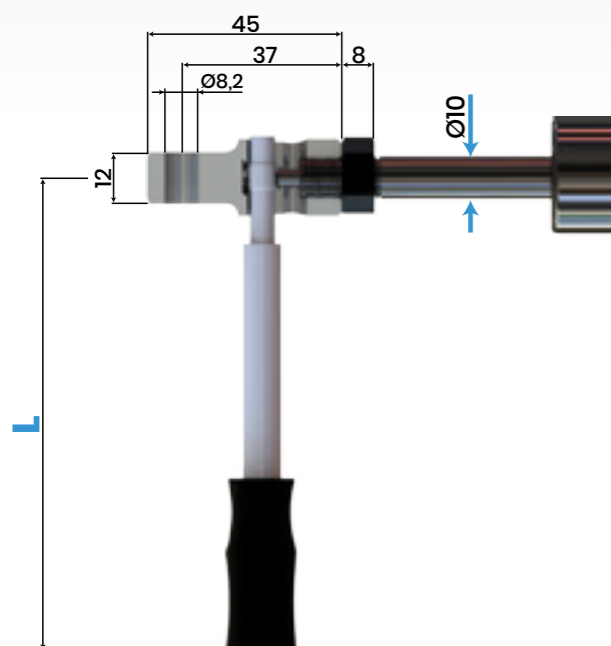

Material (KB1)	Surface Treatment
Zamac 5 alloy	White zinc plated (Zn/White)
Weight (KB1)	Components
0,045 KG	KB1;KK1
Length Alternatives	
L = 80	KKM1-80
L = 120	KKM1-120
L = 160	KKM1-160
L = 210	KKM1-210
L = 250	KKM1-250

KKM2

FEATURES

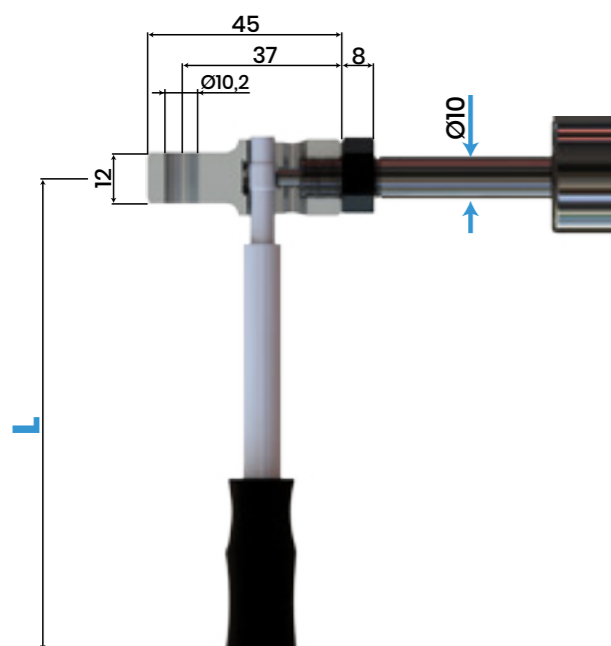

Material (KB2)	Surface Treatment
Zamac 5 alloy	White zinc plated (Zn/White)
Weight (KB2)	Components
0,045 KG	KB2;KK2
Length Alternatives	
L = 80	KKM2-80
L = 120	KKM2-120
L = 160	KKM2-160
L = 210	KKM2-210
L = 250	KKM2-250

LAMA LEVER CONTROL



LKM1

FEATURES

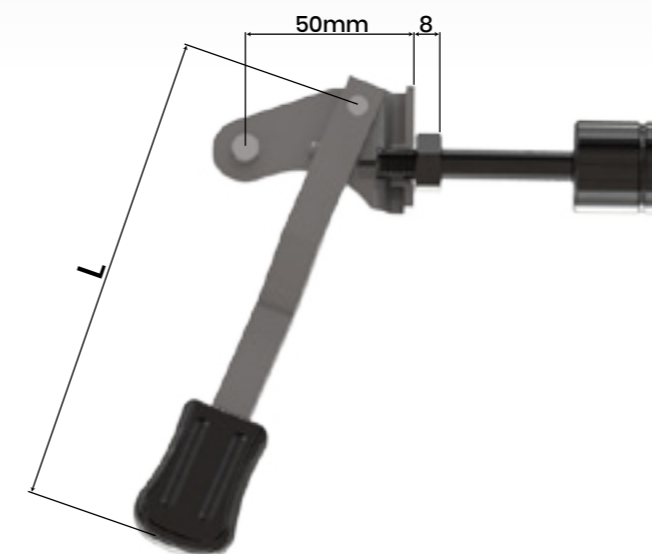

Material (LB1)	Surface Treatment
ERD 110	White zinc plated (Zn/White)
Weight (LB1)	Components
? KG	LB1;LK1
Length Alternatives	
L = 80	LKM1-80
L = 120	LKM1-120
L = 160	LKM1-160
L = 210	LKM1-210
L = 250	LKM1-250

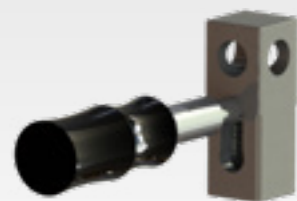

UNIVERSAL LEVER CONTROL

KKM3

FEATURES

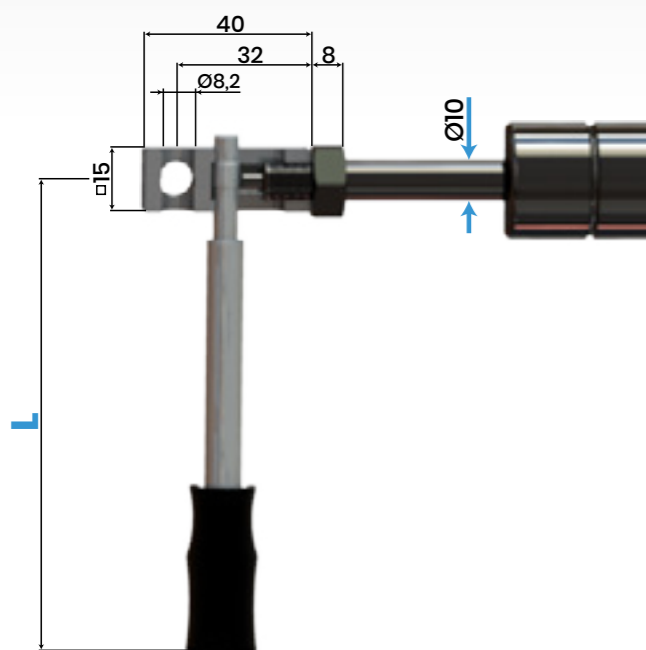

Material (KB3)	Surface Treatment
Zamac 5 alloy	White zinc plated (Zn/White)
Weight (KB3)	Components
0,013 KG	KB3:KK3
Length Alternatives	
L = 80	KKM3-80
L = 120	KKM3-120
L = 160	KKM3-160
L = 210	KKM3-210
L = 250	KKM3-250

WIRE CONTROL



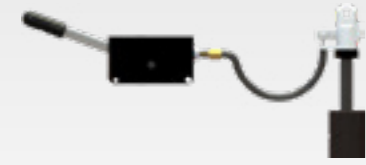

WIRE RELEASE SYSTEM

PR012

FEATURES

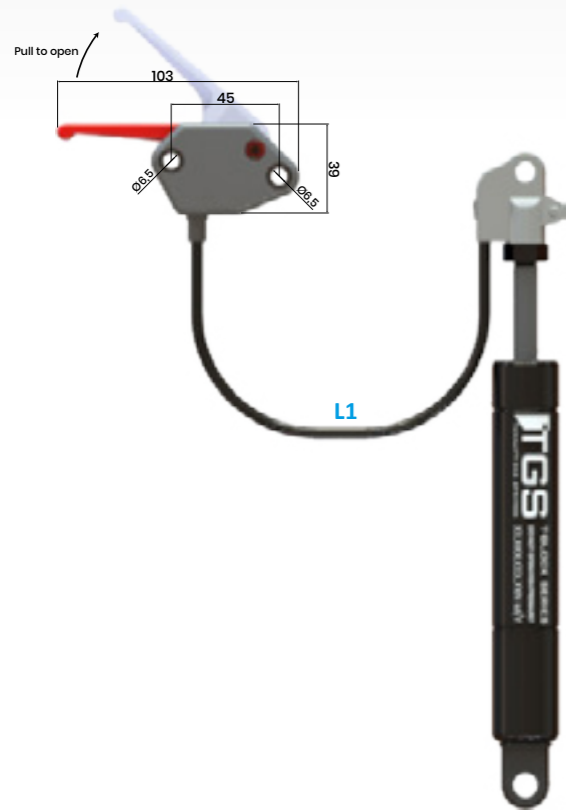

Connector	Zamac	Hose	Plastic
Box	Plastic	Lever	Plastic
Order Example			
L = 400			PR012-400
L = 500			PR012-500
L = 750			PR012-750
L = 900			PR012-900

HYDRAULIC CONTROL

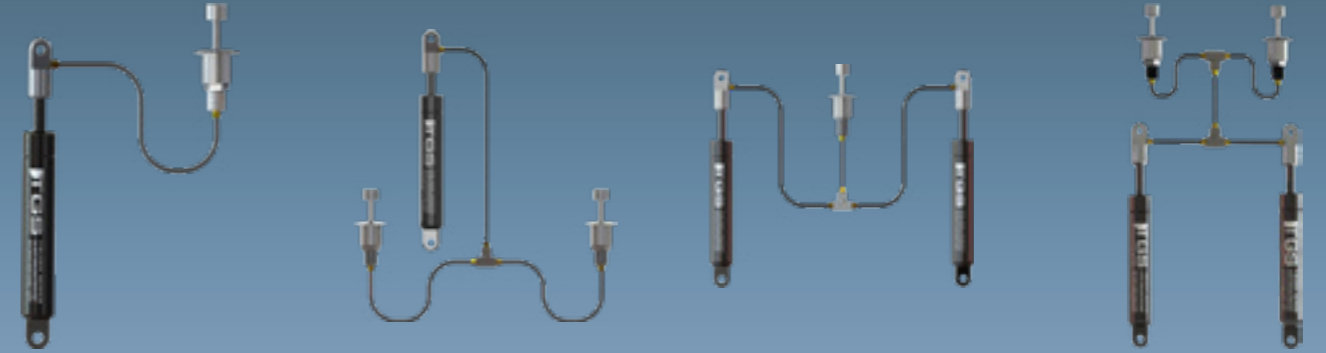

HRS 1B-1H



HRS.1B-1H

FEATURES

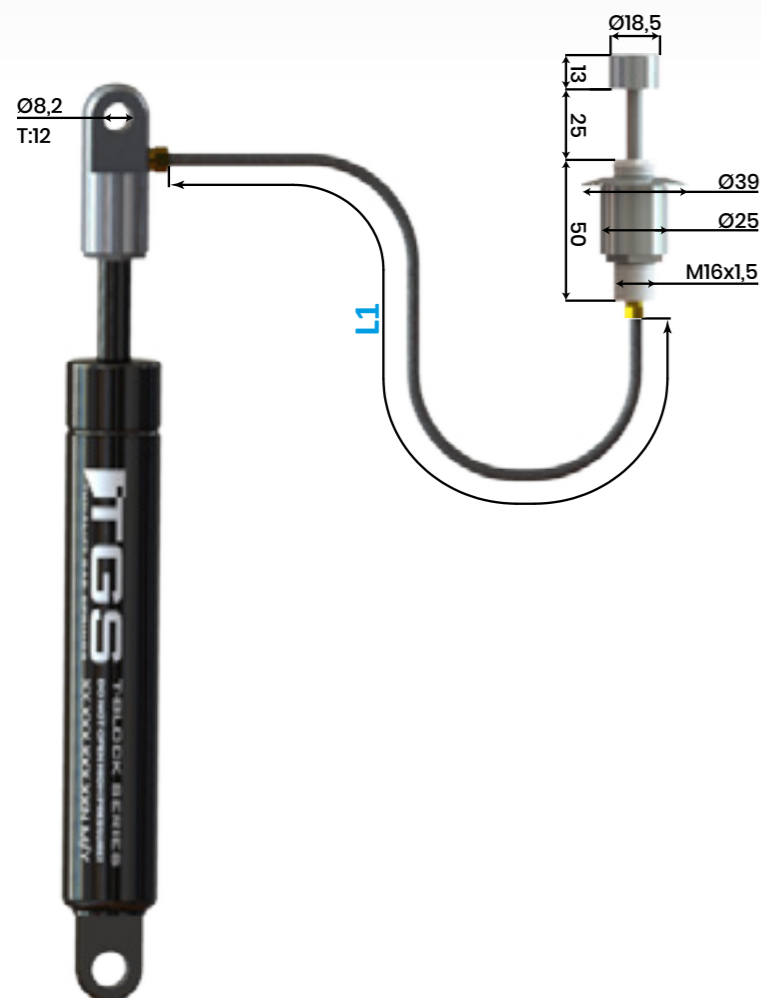

Connector	Hose
Aluminium	Plastic
Button	Piston Rod
Aluminium	Steel (Zinc Plated)
Order Example	HRS.1B-1H-(L1)
L1 = (100mm - 2000mm)	

HRS 1B-2H



HRS.1B-2H

FEATURES

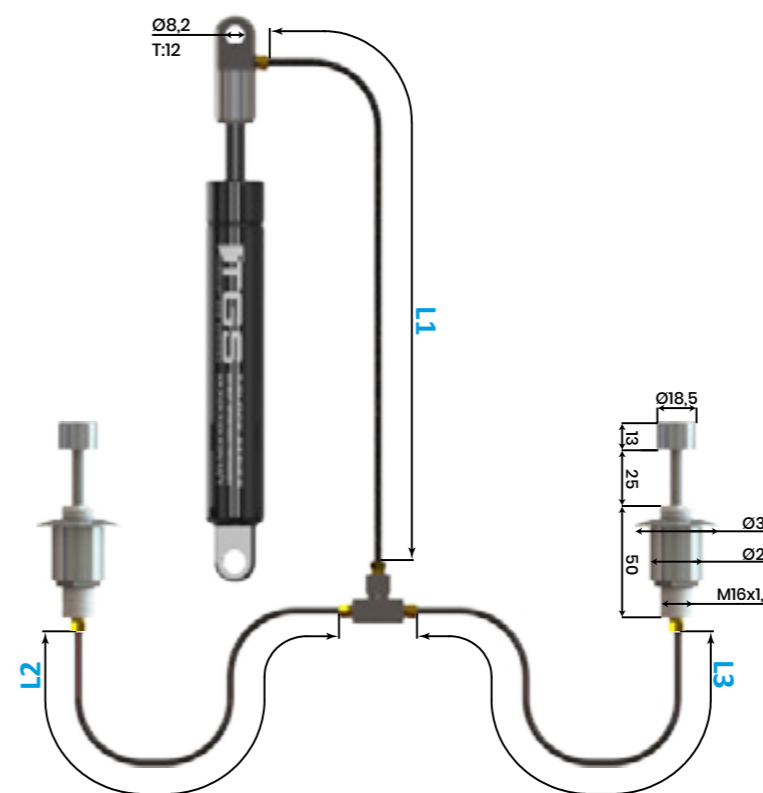

Connector	Hose
Aluminium	Plastic
Button	Piston Rod
Aluminium	Steel (Zinc Plated)
Order Example	HRS.1B-2H-(L1-L2-L3)
L1 = (100mm - 2000mm)	
L2 = (100mm - 2000mm)	
L3 = (100mm - 2000mm)	



HRS 2B-1H

HRS.2B-1H

FEATURES

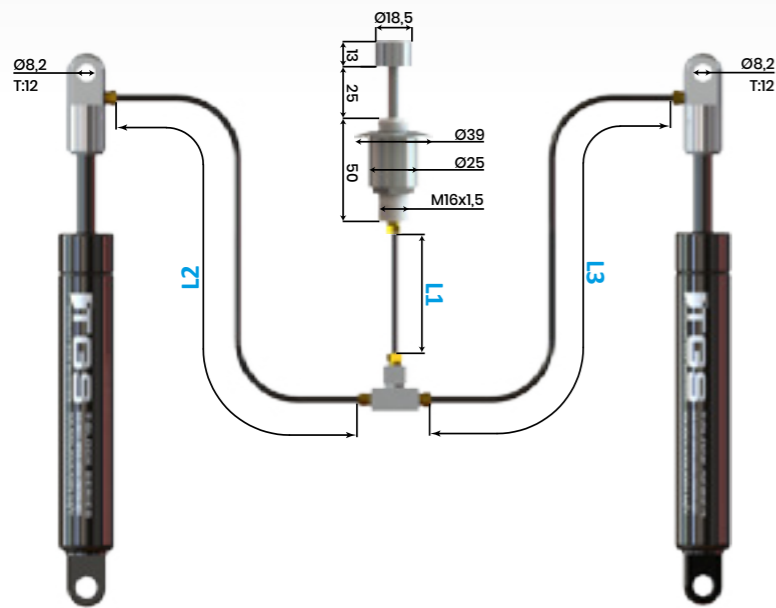

Connector	Hose
Aluminium	Plastic
Button	Piston Rod
Aluminium	Steel (Zinc Plated)
Order Example	HRS.2B-1H-(L1-L2-L3)
L1 = (100mm - 2000mm)	
L2 = (100mm - 2000mm)	
L3 = (100mm - 2000mm)	



HRS 2B-2H

HRS.2B-1H

FEATURES

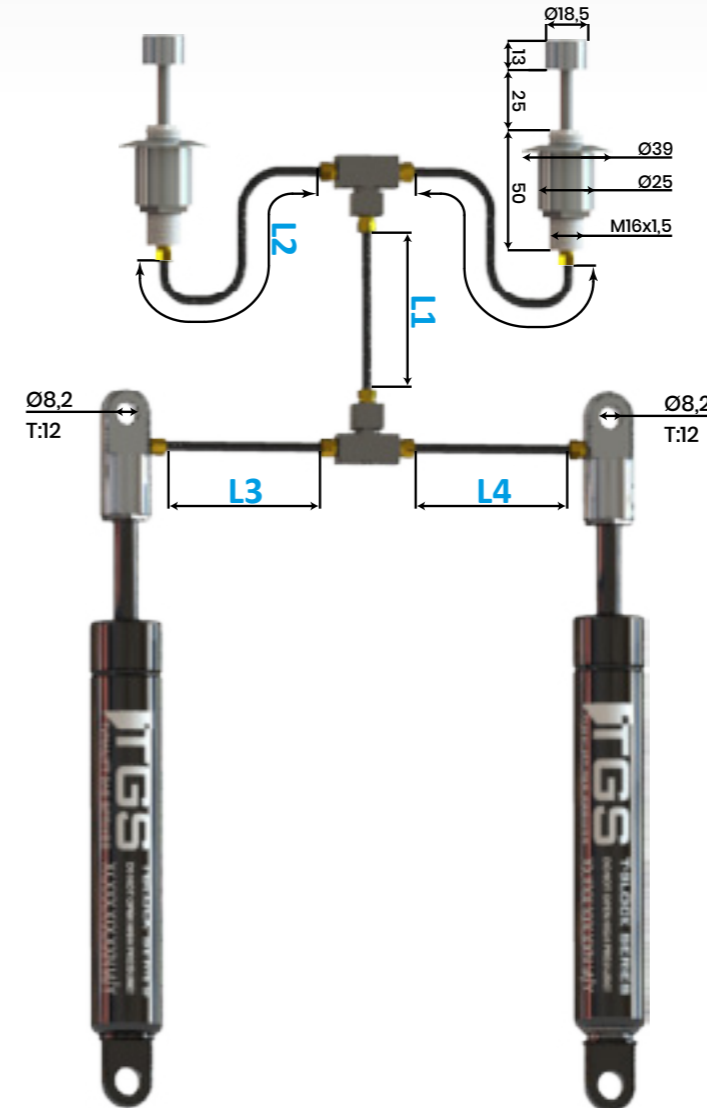

Connector	Hose
Aluminium	Plastic
Button	Piston Rod
Aluminium	Steel (Zinc Plated)
Order Example	HRS.2B-2H-(L1-L2-L3-L4)
L1 = (100mm - 2000mm)	
L2 = (100mm - 2000mm)	
L3 = (100mm - 2000mm)	
L4 = (100mm - 2000mm)	

END FITTINGS



RELEASE HEAD

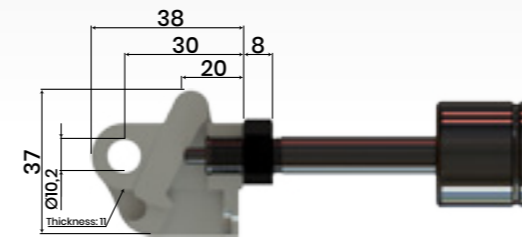

FEATURES		K1001
Material Information		Zamac 5 alloy
Surface Treatment		White zinc plated (Zn/White)
Unit Weight		0,51 KG

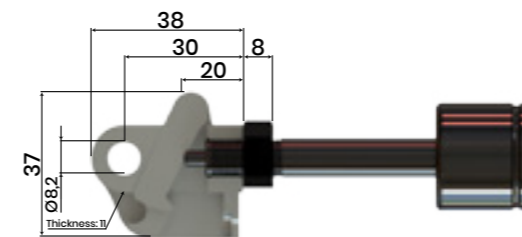

FEATURES		K1002
Material Information		Zamac 5 alloy
Surface Treatment		White zinc plated (Zn/White)
Unit Weight		0,51 KG

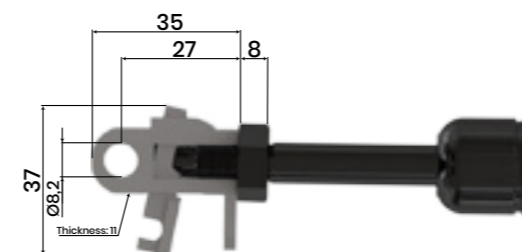

FEATURES		F031
Material Information		Zamac 5 alloy
Surface Treatment		White zinc plated (Zn/White)
Unit Weight		0,51 KG

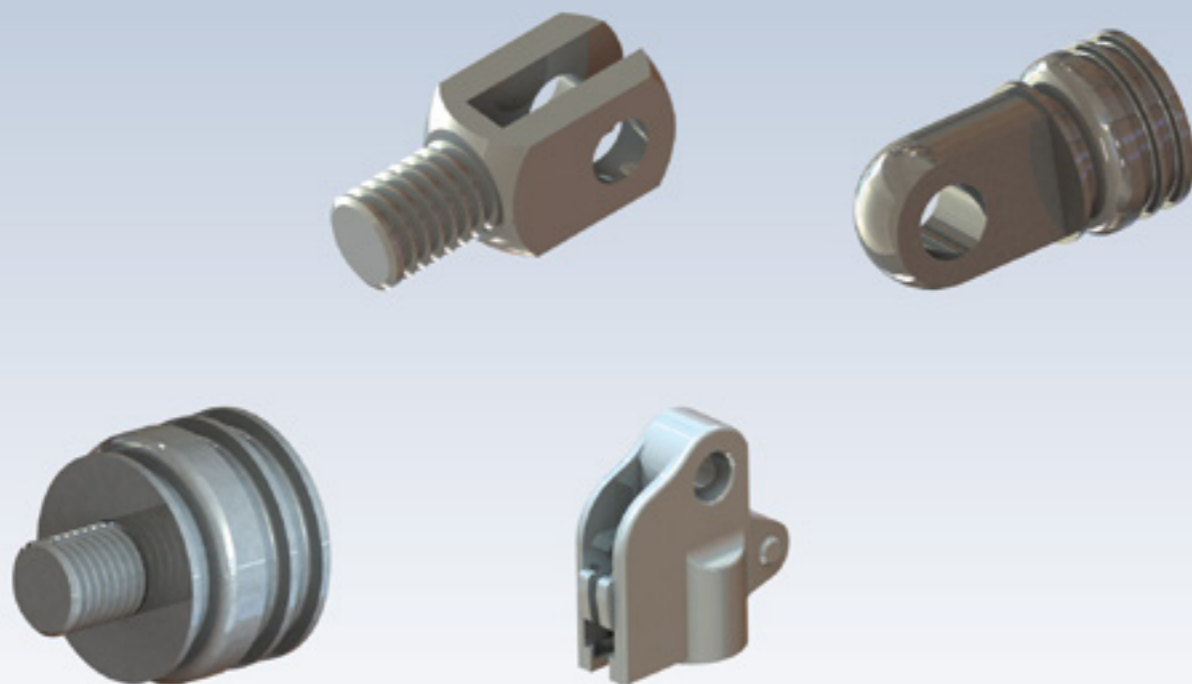



EYE

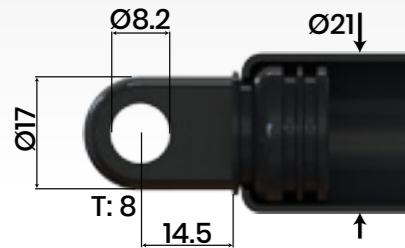

FEATURES TPY01

Material Information	Steel
Surface Treatment	Black painted
Unit Weight	- KG

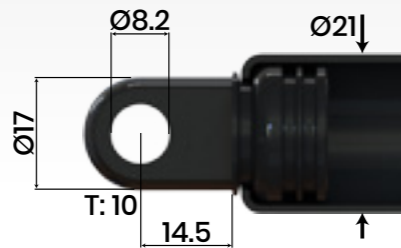

FEATURES TPY03

Material Information	Steel
Surface Treatment	Black painted
Unit Weight	- KG

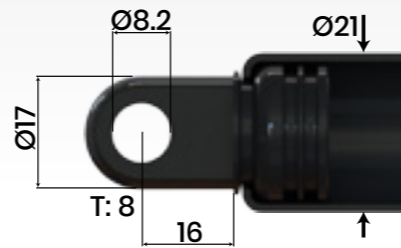

FEATURES TPY05

Material Information	Steel
Surface Treatment	Black painted
Unit Weight	- KG

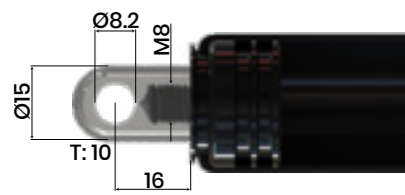

FEATURES Y009

Material Information	Steel
Surface Treatment	Black painted
Unit Weight	- KG

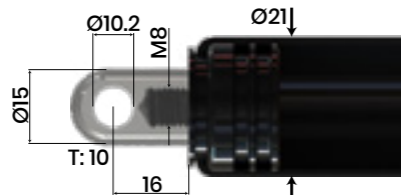

FEATURES Y010

Material Information	Steel
Surface Treatment	Black painted
Unit Weight	- KG

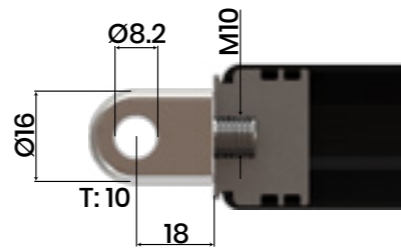

FEATURES Y602

Material Information	Steel
Surface Treatment	Black painted
Unit Weight	- KG

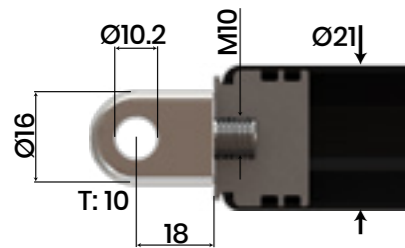

FEATURES Y603

Material Information	Steel
Surface Treatment	Black painted
Unit Weight	- KG

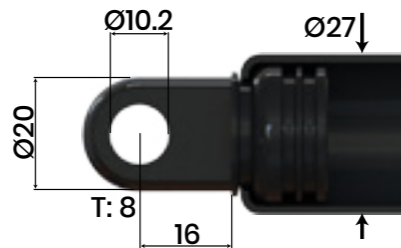

FEATURES TPY02

Material Information	Steel
Surface Treatment	Black painted
Unit Weight	- KG

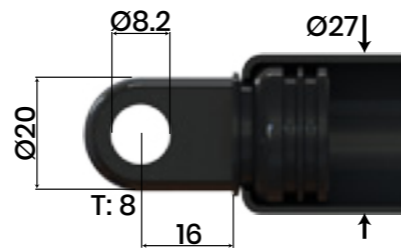

FEATURES TPY04

Material Information	Steel
Surface Treatment	Black painted
Unit Weight	- KG



CLEVIS

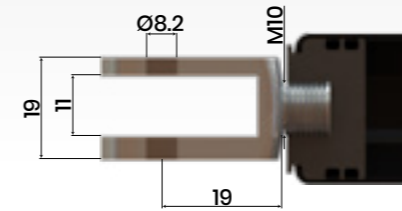

FEATURES F105

Material Information	Steel
Surface Treatment	White zinc plated (Zn/White)
Unit Weight	- KG

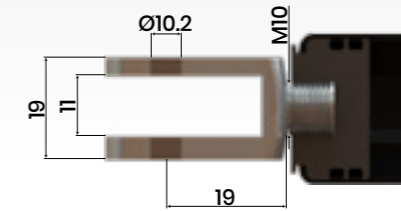

FEATURES F106

Material Information	Steel
Surface Treatment	White zinc plated (Zn/White)
Unit Weight	- KG

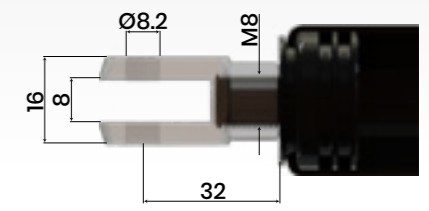

FEATURES F005

Material Information	Steel
Surface Treatment	White zinc plated (Zn/White)
Unit Weight	- KG

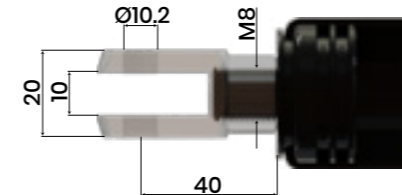

FEATURES F006

Material Information	Steel
Surface Treatment	White zinc plated (Zn/White)
Unit Weight	- KG

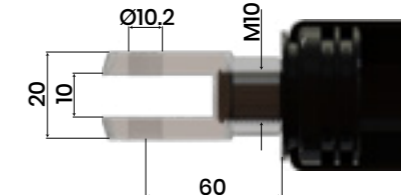

FEATURES F008

Material Information	Steel
Surface Treatment	White zinc plated (Zn/White)
Unit Weight	- KG



THREAD

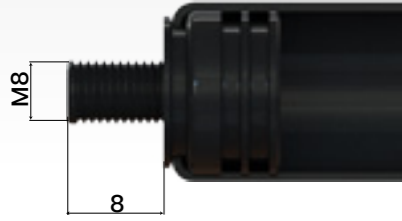

FEATURES **TPE02**

Material Information	Steel
Surface Treatment	Black painted
Unit Weight	- KG

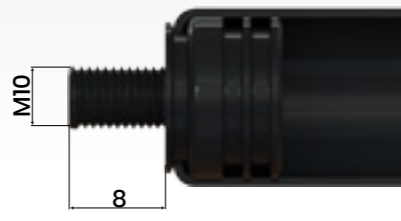

FEATURES **TPE04**

Material Information	Steel
Surface Treatment	Black painted
Unit Weight	- KG

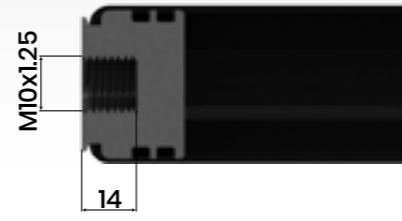

FEATURES **TPD02**

Material Information	Steel
Surface Treatment	Black painted
Unit Weight	- KG



"Feel Safe!"
www.tunalift.com

Bursa, Turkey

+90 224 211 44 73

info@tunalift.com

www.tunalift.com